



IVECO

Daily



IVECO DAILY 9 M³ H1

Voor informatie over prijzen, montage en wat inbegrepen is in onze voorbeeldinrichtingen, scan de QR-code op de eerste pagina.

Bij elektrische of hybride wagens raden we aan de installatie door een ervaren ombouwer te laten uitvoeren vanwege de batterijen en bekabeling van +/- 400 volt. Eventuele kosten voor een extra houten vloer kunnen worden toegevoegd.

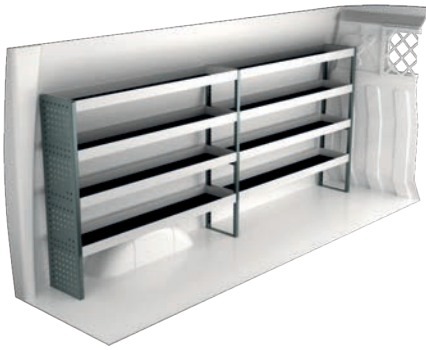

Art.Nr	LxDxH	Kg
F41400	2874x300x1220 mm	56

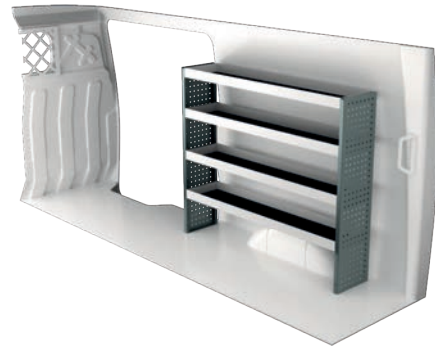

Art.Nr	LxDxH	Kg
F41401	1453x300x1220 mm	33

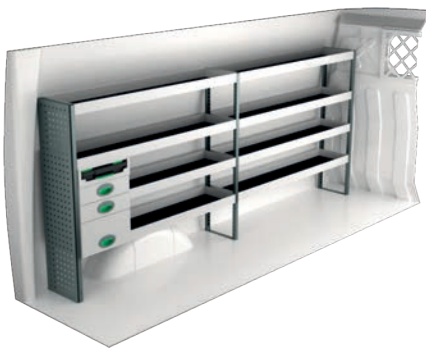

Art.Nr	LxDxH	Kg
F41402	2874x300x1220 mm	71

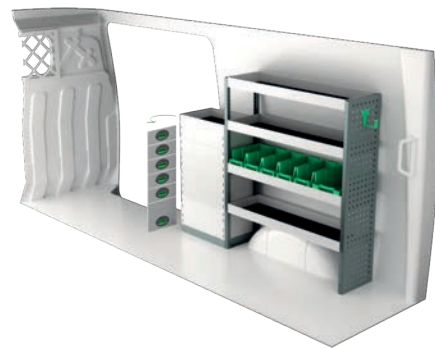

Art.Nr	LxDxH	Kg
F41403	1530x300x1220 mm	60

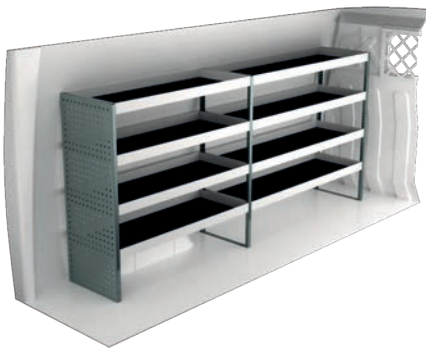

Art.Nr	LxDxH	Kg
F41404	2661x470x1220 mm	74



Art.Nr	LxDxH	Kg
F41405	1453x470x1220 mm	50

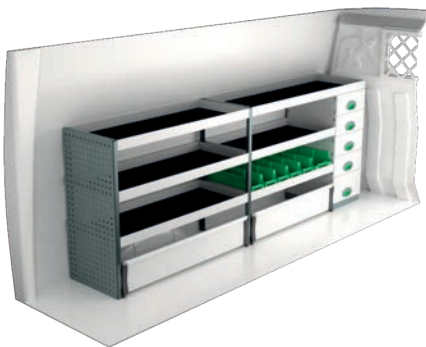

Art.Nr	LxDxH	Kg
F41406	2661x470x1000 mm	92

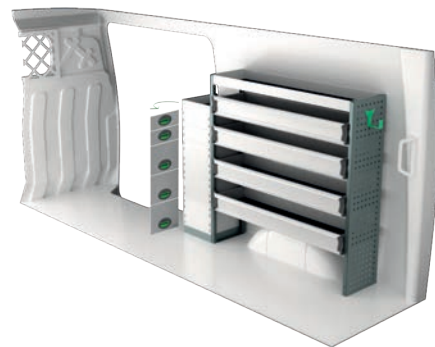

Art.Nr	LxDxH	Kg
F41407	1539x300x1220 mm	63

IVECO DAILY 10,8 M³ H2

Voor informatie over prijzen, montage en wat inbegrepen is in onze voorbeeldrichtingen, scan de QR-code op de eerste pagina.

Bij elektrische of hybride wagens raden we aan de installatie door een ervaren ombouwer te laten uitvoeren vanwege de batterijen en bekabeling van +/- 400 volt. Eventuele kosten voor een extra houten vloer kunnen worden toegevoegd.

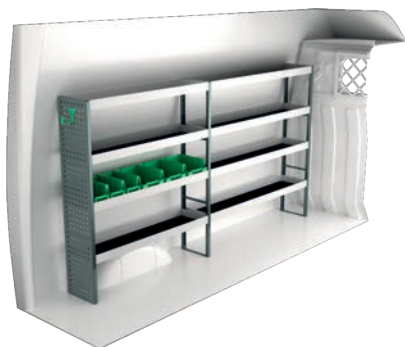

Art.Nr	LxDxH	Kg
F41420	2662x300x1440 mm	58

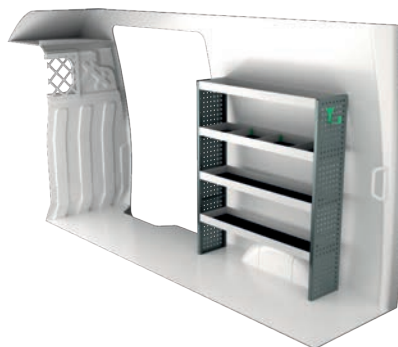

Art.Nr	LxDxH	Kg
F41421	1242x300x1440 mm	32

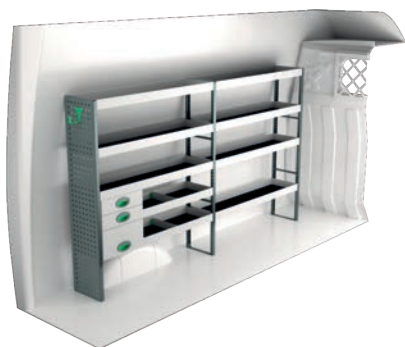

Art.Nr	LxDxH	Kg
F41422	2450x300x1440 mm	66

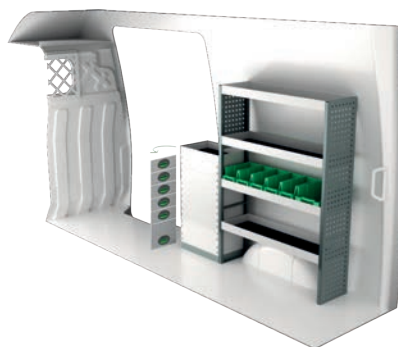

Art.Nr	LxDxH	Kg
F41423	1531x300x1440 mm	63



Art.Nr	LxDxH	Kg
F41424	2662x470x1440 mm	76

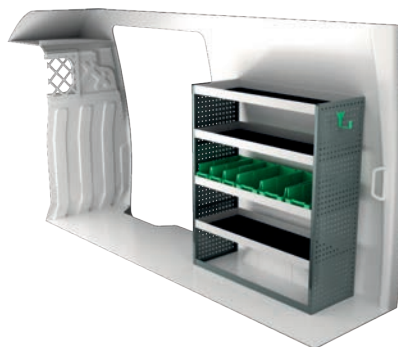

Art.Nr	LxDxH	Kg
F41425	1242x470x1440 mm	50

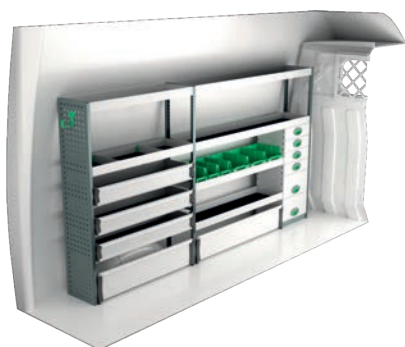

Art.Nr	LxDxH	Kg
F41426	2662x300x1440 mm	96

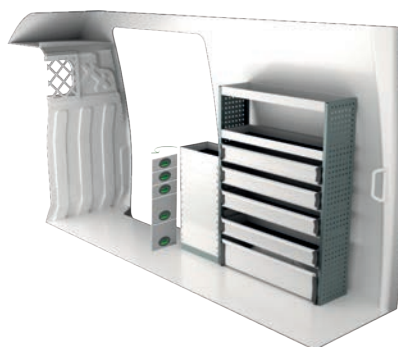

Art.Nr	LxDxH	Kg
F41427	1531x300x1440 mm	75

IVECO DAILY 12 M³ H2

Voor informatie over prijzen, montage en wat inbegrepen is in onze voorbeeldinrichtingen, scan de QR-code op de eerste pagina.

Bij elektrische of hybride wagens raden we aan de installatie door een ervaren ombouwer te laten uitvoeren vanwege de batterijen en bekabeling van +/- 400 volt. Eventuele kosten voor een extra houten vloer kunnen worden toegevoegd.

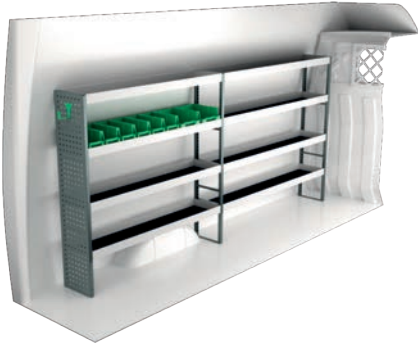

Art.Nr	LxDxH	Kg
F41440	3054x300x1440 mm	64

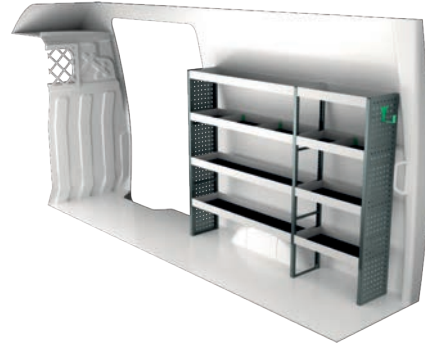

Art.Nr	LxDxH	Kg
F41441	1880x300x1440 mm	44

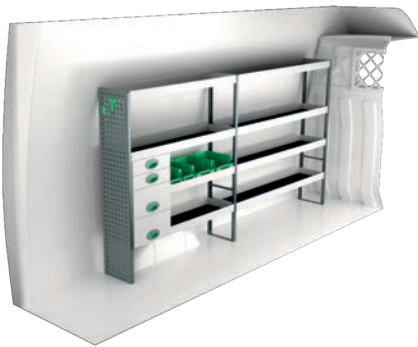

Art.Nr	LxDxH	Kg
F41442	2662x300x1440 mm	72

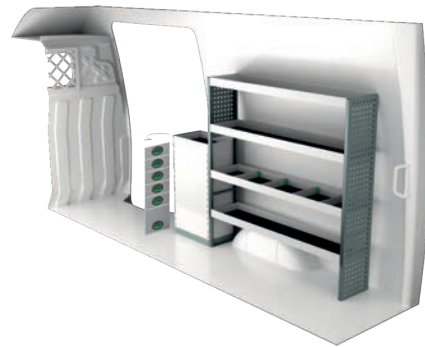

Art.Nr	LxDxH	Kg
F41443	1924x300x1440 mm	67

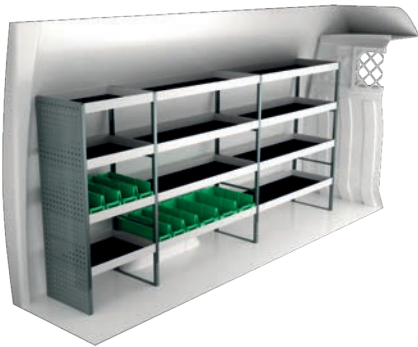

Art.Nr	LxDxH	Kg
F41444	3086x470x1440 mm	96

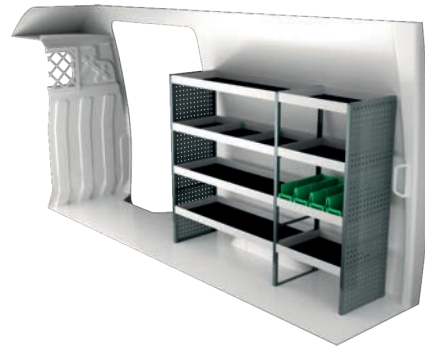

Art.Nr	LxDxH	Kg
F41445	1880x470x1440 mm	66

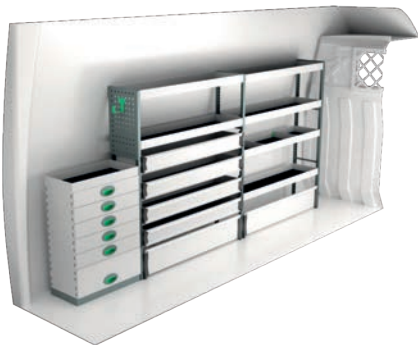

Art.Nr	LxDxH	Kg
F41446	3053x300x1440 mm	109



Art.Nr	LxDxH	Kg
F41447	1955x300x1440 mm	89

IVECO DAILY 16 M³ H2

Voor informatie over prijzen, montage en wat inbegrepen is in onze voorbeeldrichtingen, scan de QR-code op de eerste pagina.

Bij elektrische of hybride wagens raden we aan de installatie door een ervaren ombouwer te laten uitvoeren vanwege de batterijen en bekabeling van +/- 400 volt. Eventuele kosten voor een extra houten vloer kunnen worden toegevoegd.

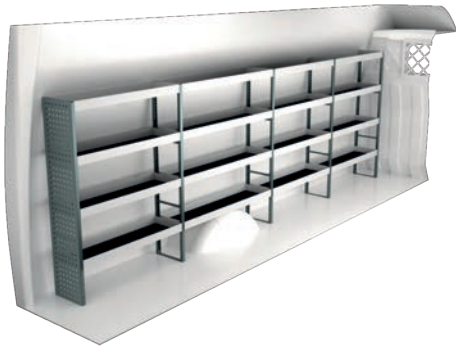

Art.Nr	LxDxH	Kg
F41460	4323x300x1440 mm	89

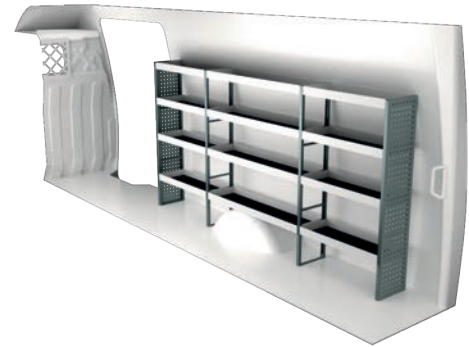

Art.Nr	LxDxH	Kg
F41461	2870x300x1440 mm	60

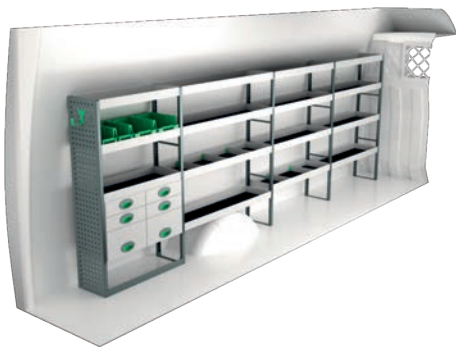

Art.Nr	LxDxH	Kg
F41462	4110x300x1440 mm	110

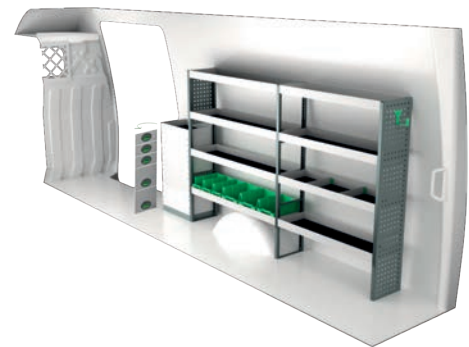

Art.Nr	LxDxH	Kg
F41463	2736x300x1440 mm	83

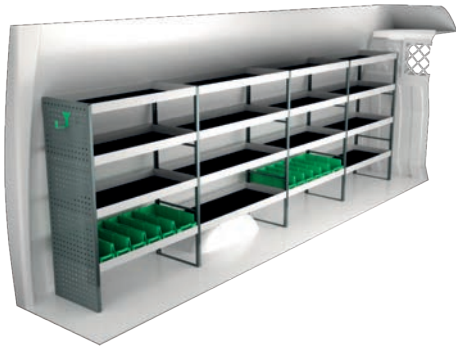

Art.Nr	LxDxH	Kg
F41464	4323x470x1440 mm	129

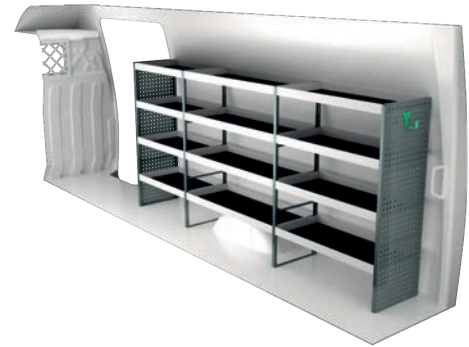

Art.Nr	LxDxH	Kg
F41465	3083x470x1440 mm	96

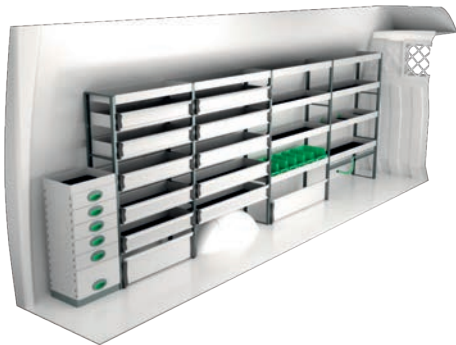

Art.Nr	LxDxH	Kg
F41466	4322x300x1440 mm	147

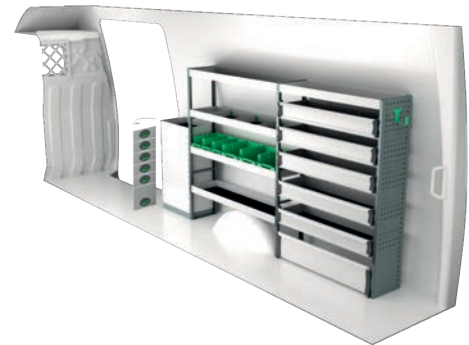

Art.Nr	LxDxH	Kg
F41467	2737x300x1440 mm	104

IVECO DAILY 17,5 M³ H2

Voor informatie over prijzen, montage en wat inbegrepen is in onze voorbeeldinrichtingen, scan de QR-code op de eerste pagina.

Bij elektrische of hybride wagens raden we aan de installatie door een ervaren ombouwer te laten uitvoeren vanwege de batterijen en bekabeling van +/- 400 volt. Eventuele kosten voor een extra houten vloer kunnen worden toegevoegd.

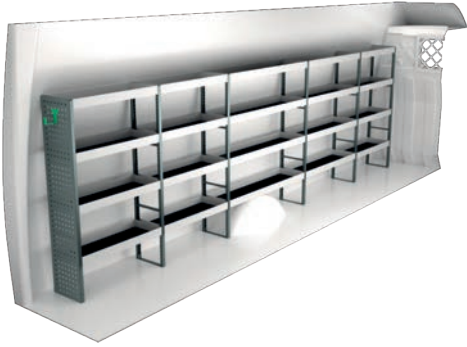

Art.Nr	LxDxH	Kg
F41480	4712x300x1440 mm	94

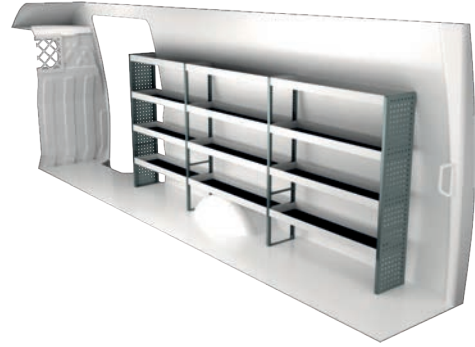

Art.Nr	LxDxH	Kg
F41481	3475x300x1440 mm	74

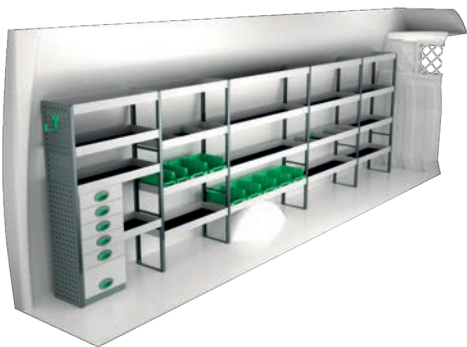

Art.Nr	LxDxH	Kg
F41482	4746x300x1440 mm	123

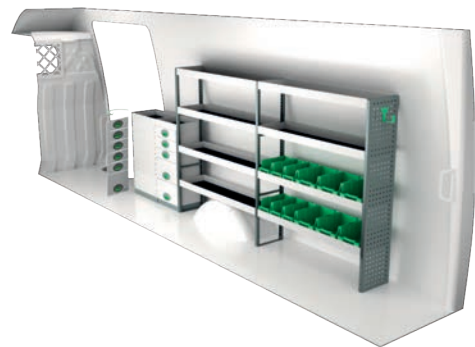

Art.Nr	LxDxH	Kg
F41483	3308x300x1440 mm	116

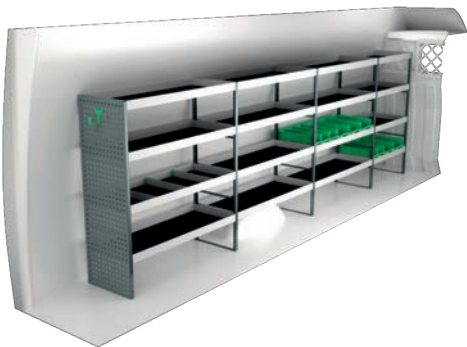

Art.Nr	LxDxH	Kg
F41484	4468x470x1440 mm	134

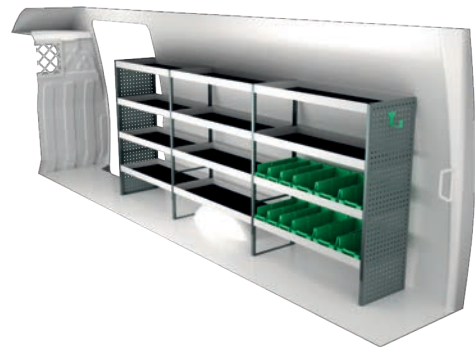

Art.Nr	LxDxH	Kg
F41485	3475x470x1440 mm	111

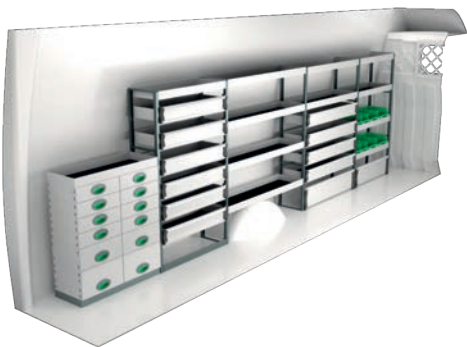

Art.Nr	LxDxH	Kg
F41486	4680x300x1440 mm	175

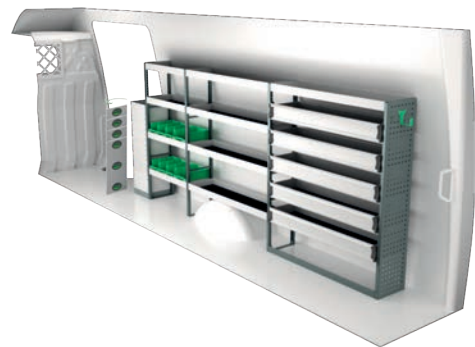

Art.Nr	LxDxH	Kg
F41487	3470x300x1440 mm	114

IVECO DAILY 13,4 M³ H3

Voor informatie over prijzen, montage en wat inbegrepen is in onze voorbeeldinrichtingen, scan de QR-code op de eerste pagina.

Bij elektrische of hybride wagens raden we aan de installatie door een ervaren ombouwer te laten uitvoeren vanwege de batterijen en bekabeling van +/- 400 volt. Eventuele kosten voor een extra houten vloer kunnen worden toegevoegd.

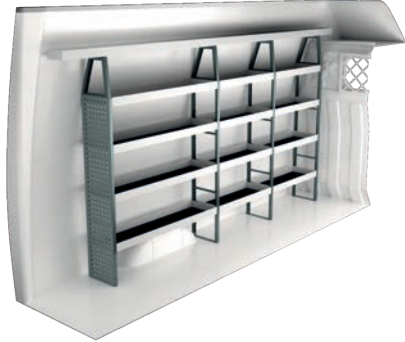

Art.Nr	LxDxH	Kg
F41500	2868x300x1795 mm	72

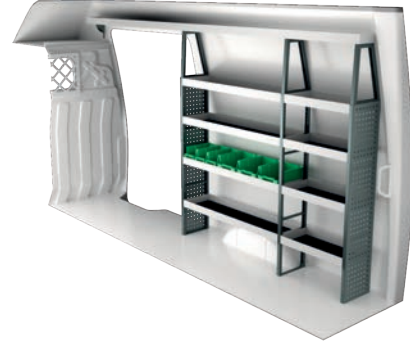

Art.Nr	LxDxH	Kg
F41501	1876x300x1840 mm	61

IVECO DAILY 18 M³ H3

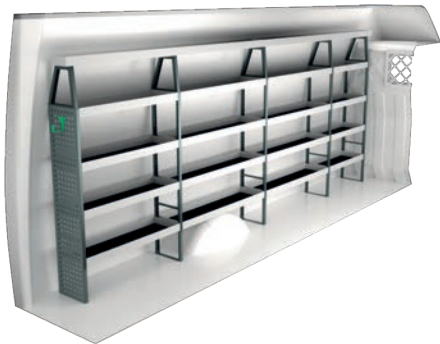

Art.Nr	LxDxH	Kg
F41520	4288x300x1795 mm	108

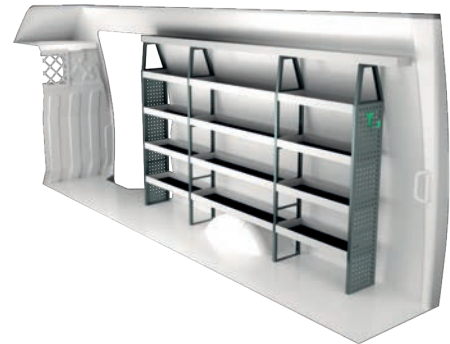

Art.Nr	LxDxH	Kg
F41521	2870x300x1795 mm	75

IVECO DAILY 19,6 M³ H3

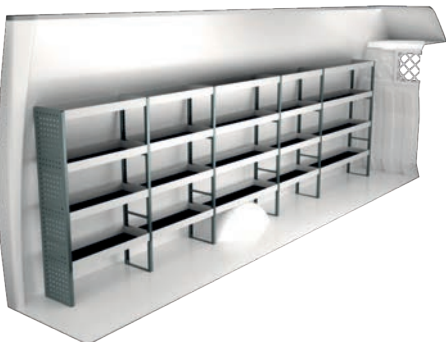

Art.Nr	LxDxH	Kg
F41540	4712x300x1440 mm	94



Art.Nr	LxDxH	Kg
F41541	3475x300x1840 mm	88

INFORMATIE



ALGEMEEN

Deze basiskits bevatten alles wat u op de tekening ziet, inclusief de rubber matten voor alle legborden en montage onderdelen.

System Edström is SS-EN ISO 9001:2015 gecertificeerd. Hiermee wordt onze administratieve kwaliteit en onze accuraatheid in leveringen verzekerd.

Alle gebruikte materialen bij System Edstrom kunnen voor 100% gerecycleerd worden. Wij zijn SS-EN ISO 14001:2015 gecertificeerd.



ONTHOUDEN

Door System Edström voor uw dienstvoertuig te kiezen, zet u de eerste en belangrijkste stap om uw mobiele werkplek veilig en functioneel te maken. Van nu af aan bent u degene die beslist hoe veilig en functioneel uw werkplek wordt.

Denk eraan:
U draagt als chauffeur de eindverantwoordelijkheid. Indien u of iemand anders gewond raakt door materiaal dat in uw auto rondslingerd of niet degelijk bevestigd is.

Houd rekening met het maximale laadvermogen van het voertuig!



VEILIGHEID

Onze producten worden op 2 manieren getest. De eerste en belangrijkste zijn crashtests uitgevoerd door enerzijds Milbrook in Engeland (ECE17:07) en anderzijds Valutec in Frankrijk (INRS NS286).



Bankvijs

Diepte	Breedte	Hoogte	Kg	Art.Nr
360	135	140	10,3	5004

De bankvijs wordt geleverd met pijpklem en draaiplaatje. Max. Opening is 140 mm.



Bankvijs houder

Diepte	Breedte	Hoogte	⇔	Kg	Art.Nr
1110	170	195	600	9,4	5012
1110	170	80	600	8,9	5013

De bevestigingsplaat heeft een oppervlakte van 170 x 158 mm. De cover is inbegrepen.

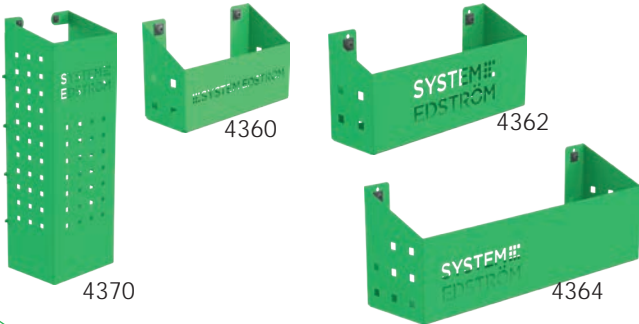

Opbergbakjes

Diepte	Breedte	Hoogte	Kg	Art.Nr
82	200	80	0,5	4360
82	285	102	0,8	4362
122	455	122	1,5	4364
153	179	575	3,0	4370

Deze verschillende bakjes zijn een oplossing voor uw opbergproblemen.



Interne ladder houder

Lengte	Kg	Art.Nr
2400	5,5	T8900

Hang uw ladder op tegen het dak en met een simpele beweging kan de ladder naar de achterdeur toe getrokken worden.



Slang/Kabel houder

Diepte	Breedte	Hoogte	Kg	Art.Nr
79	267	168	0,5	4077

Silicone houder

66	194	123	0,4	4349
----	-----	-----	-----	------

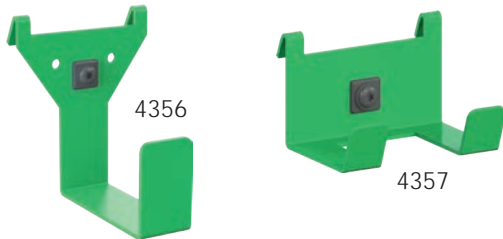

Universele haak

Diepte	Breedte	Hoogte	Kg	Art.Nr
85	80	100	0,2	4356
61	83	55	0,1	4357

Bevestig op een perfo paneel of aan een legbord.

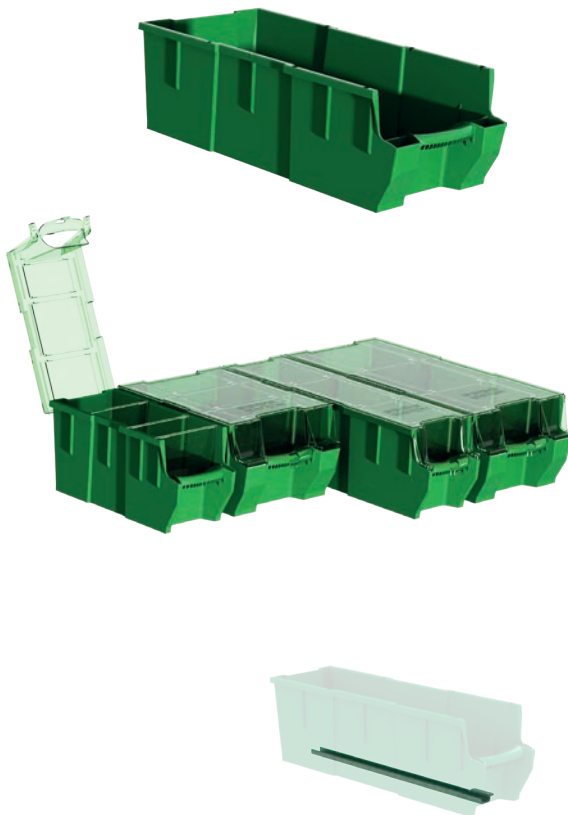

Plastieken sorteerbakken

Diepte	Breedte	Hoogte	Kg	Art.nr
300	145	154	0,4	3050
300	235	154	0,5	3052
470	145	154	0,5	3055
470	235	154	0,5	3057

Transparant deksel voor sorteerbakken

Diepte	Breedte	Past bij	Kg	Art.nr
300	150	3050	0,2	3060
300	240	3052	0,2	3062
470	150	3055	0,2	3065
470	240	3057	0,4	3067

Tussenschotten voor sorteerbakken

Breedte	Hoogte	Past bij	Art.nr
140	154	3050, 55	3070
230	154	3052, 57	3072

Houder voor sorteerbakken

Diepte	Kg	Art.nr
300	0,1	3081
470	0,2	3082

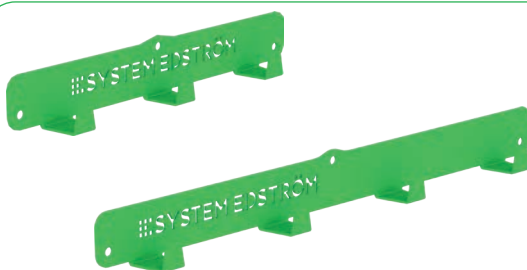

Kledinghaak

Diepte	Breedte	Hoogte	Kg	Art.Nr
31	295	40	0,3	2706
31	465	40	0,5	2708

Wij noemen dit een kledinghaak. Maar natuurlijk kan u dit gebruiken om allerlei zaken op te hangen.



Spanband met klemgesp

Informatie	Breedte	Art.Nr
1200 mm, nylon band	25	4365
1000 mm, elastische band	25	4366

De haakjes passen op onze perfo panelen.



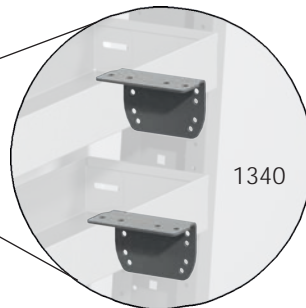
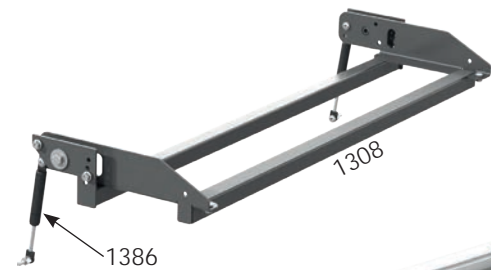
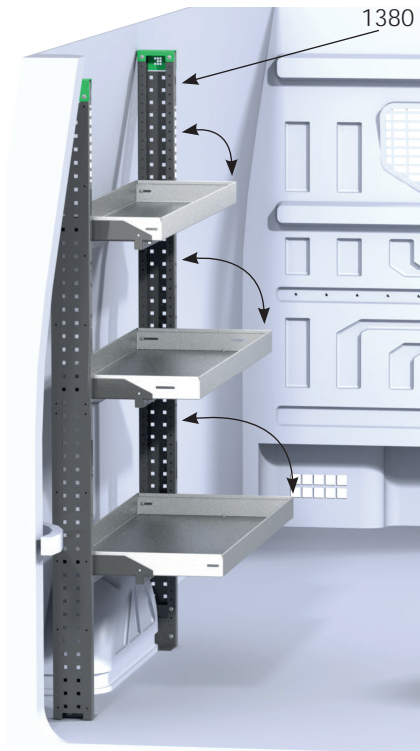

Flexi frame

Diepte	Breedte	Hoogte	Info.	Kg	Art.Nr
112	32	1788	2/set	11,8	1380
112	31	1788	1/set	4,9	1382

Flexi beugel

Diepte	Breedte	Hoogte	Shelf w.	Kg	Art.Nr
275	830	83	784	3,1	1308
275	1043	83	997	3,5	1312
275	1222	83	1176	3,9	1316
275	1435	83	1389	4,4	1322
275	1614	83	1568	4,8	1326

Flexi legbord beugel

Informatie	Kg	Art.Nr
160 mm legborden, 2/set	0,6	1340
300, 400 & 470 mm legborden, 2/set	1,4	1342

Flexi gasveer

Informatie	Kg	Art.Nr
2/set	0,1	1386

De frames kunnen aangepast worden naargelang uw opstelling. Het laadvermogen vermeerderd naar 100 kg indien het legbord gemonteerd wordt in een flexiplan frame. De legborden zijn aanpasbaar in 4 ingestelde hoeken: 0,4,8 en 12 graden.

Kies uw legbord, 300, 400 en/of 470 mm. Onze legborden met open voorzijde zijn ook mogelijk, 300 en 470 mm diep. De beugels passen voor alle dieptes.

Gebruik de beugel wanneer u een 160mm diep legbord wil combineren met andere dieptes. Het legbord van 160mm zal niet opklapbaar zijn.



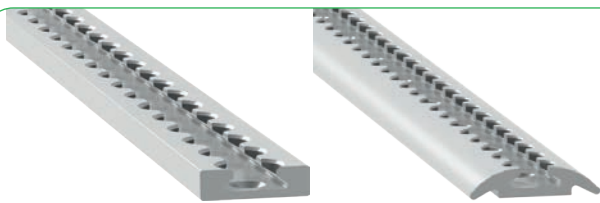

5951 & 5953

5962 & 5964



2813

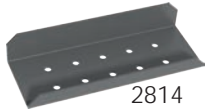

2814



5904



5905



5900

5901



5910



5911



5913



5915



5931 - 5935



5940



5993 & 5996

Vliegtuigrails

Lengte	Kg	Art.Nr
295	0,2	5951
465	0,2	5953
1000	0,8	5962
1500	1,2	5964
3000 > 6	2,5	5968

Spanoog voor vliegtuigrail

Informatie	Kg	Art.Nr
Rond aluminium	0,0	5900
Recht zwart kunststof	0,1	5901

Vliegtuigrail beugels

Informatie	Kg	Art.Nr
Montage beugel 53x80x112 mm	0,2	2813
Montage beugel voor sokkel	0,3	2814
Beugel voor frame	-	5904
Beugel voor multiplex	-	5905
Slipmoer 2xM6	-	5910
Slipmoer 3xM6	-	5911
Montagebout M8x25	-	5913
Klem fitting	0,3	5915

Vliegtuigrail spanband

Informatie	Lengte	Kg	Art.Nr
Spanband	200/ 700	0,1	5931
Spanband	200/1200	0,1	5933
Spanband	200/2200	0,2	5935
Spanband met ratel	500/2500	0,3	5940
Spanpaal	1100-1660	2,6	5993
Spanpaal	1600-2160	3,5	5996

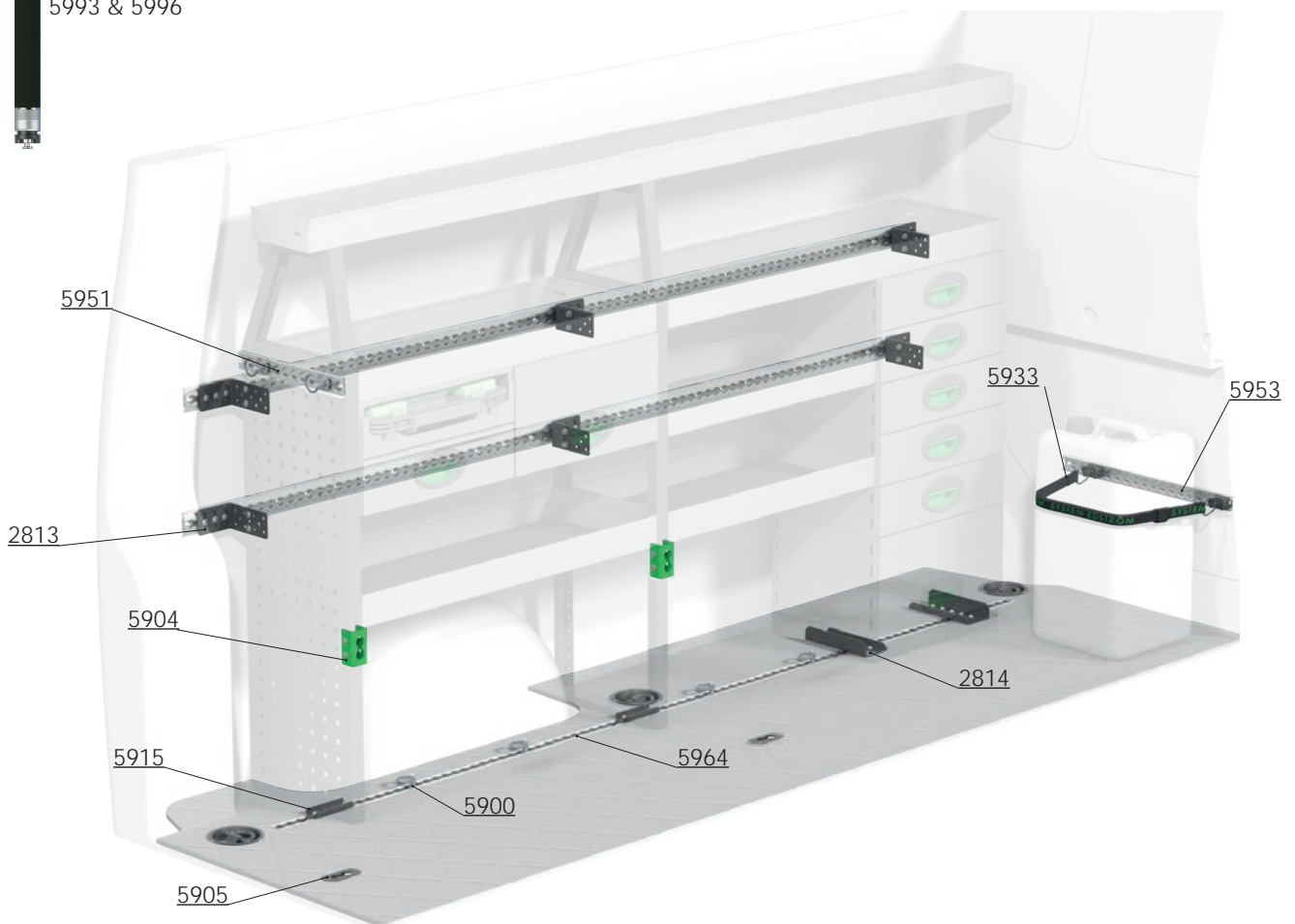



Accessoirepakket nr. 1

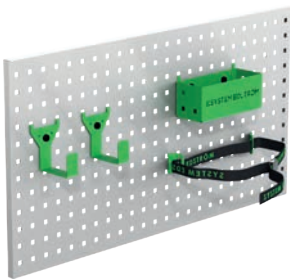

Art Nr

F11001

Perfo panelen niet inbegrepen.

Accessoirepakket nr. 2

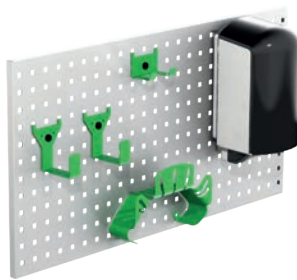

Art Nr

F11002

Perfo panelen niet inbegrepen.

Accessoirepakket nr. 3

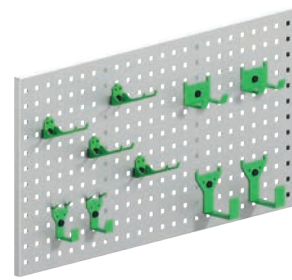

Art Nr

F11004

Perfo panelen niet inbegrepen.

www.systemedstrom.com



GARANTIE



VEILIGHEID



KWALITEIT

SYSTEM EDSTRÖM

SYSTEM EDSTRÖM BILINREDNINGAR AB
Raseborgsgatan 11
164 74 Kista
Zweden

CONTACT

Bestellingen +46 (0)10 102 95 00
Verkoop +46 (0)10 102 95 01
Shakelbord +46 (0)8 590 920 20
info@edstrom.se