

— WE CREATE MOBILE WORKPLACES —



# IVECO

Daily



SYSTEM   
EDSTRÖM

# IVECO DAILY 9 M<sup>3</sup> H1

For price information, mounting time and content in our van racking packages, scan the QR code on the first page.

On electric and hybrid vans we recommend mounting by an experienced installer. Batteries and cable harnesses for approximately 400 volt must be taken in consideration. Cost of a floor may be added.

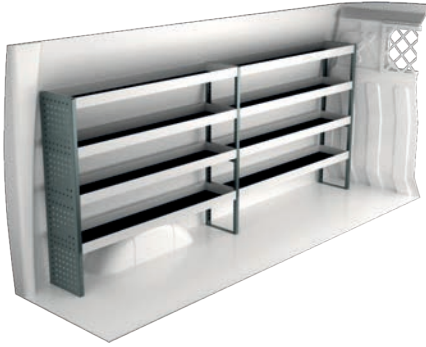

Art.No	LxDxH	Kg
F41400	2874x300x1220 mm	56

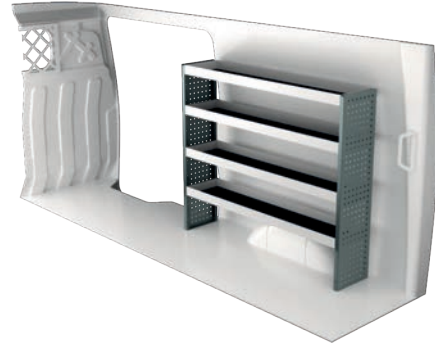

Art.No	LxDxH	Kg
F41401	1453x300x1220 mm	33

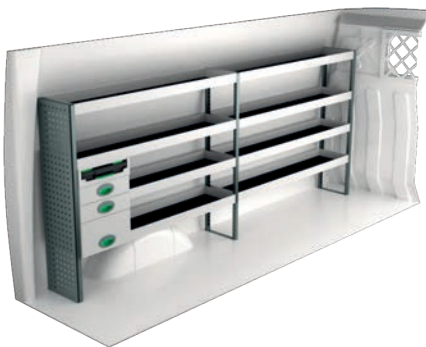

Art.No	LxDxH	Kg
F41402	2874x300x1220 mm	71

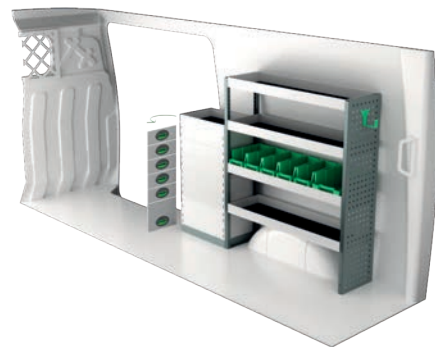

Art.No	LxDxH	Kg
F41403	1530x300x1220 mm	60

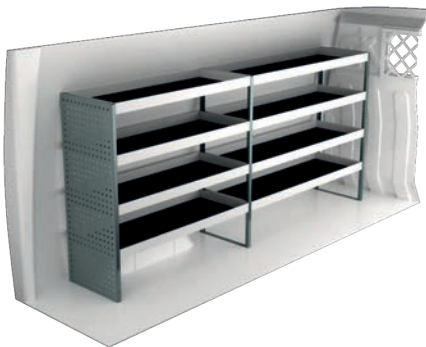

Art.No	LxDxH	Kg
F41404	2661x470x1220 mm	74

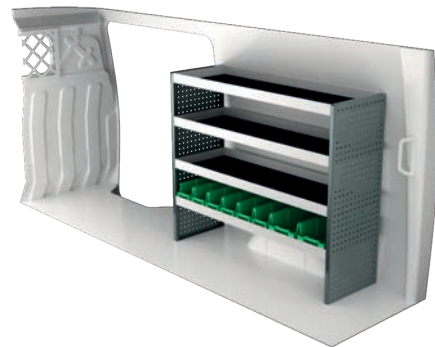

Art.No	LxDxH	Kg
F41405	1453x470x1220 mm	50

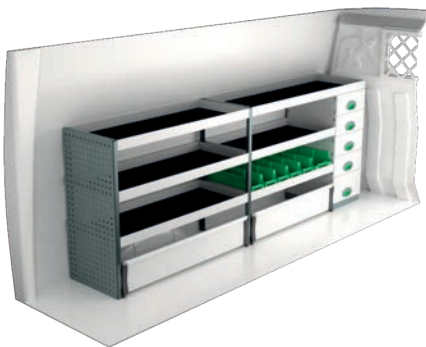

Art.No	LxDxH	Kg
F41406	2661x470x1000 mm	92

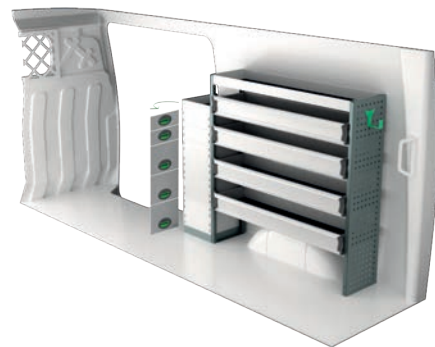

Art.No	LxDxH	Kg
F41407	1539x300x1220 mm	63

# IVECO DAILY 10,8 M<sup>3</sup> H2

For price information, mounting time and content in our van racking packages, scan the QR code on the first page.

On electric and hybrid vans we recommend mounting by an experienced installer. Batteries and cable harnesses for approximately 400 volt must be taken in consideration. Cost of a floor may be added.

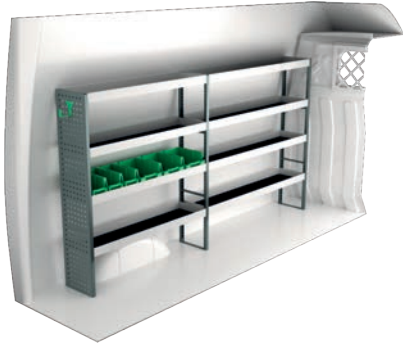

Art.No	LxDxH	Kg
F41420	2662x300x1440 mm	58

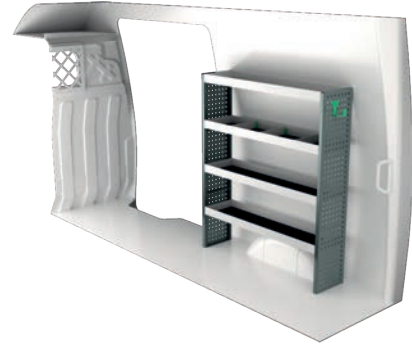

Art.No	LxDxH	Kg
F41421	1242x300x1440 mm	32

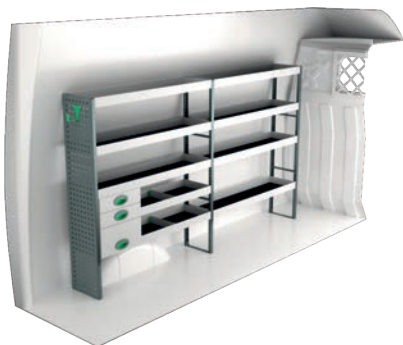

Art.No	LxDxH	Kg
F41422	2450x300x1440 mm	66

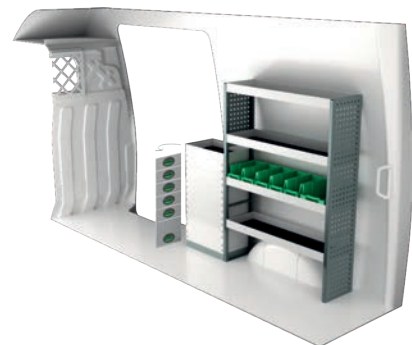

Art.No	LxDxH	Kg
F41423	1531x300x1440 mm	63

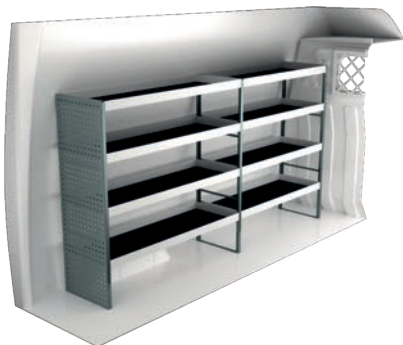

Art.No	LxDxH	Kg
F41424	2662x470x1440 mm	76

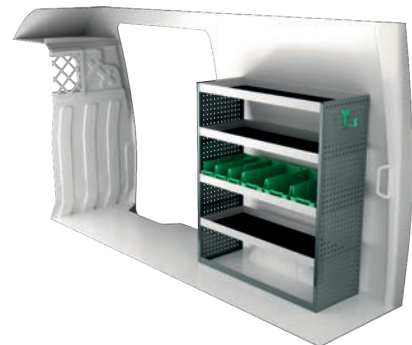

Art.No	LxDxH	Kg
F41425	1242x470x1440 mm	50

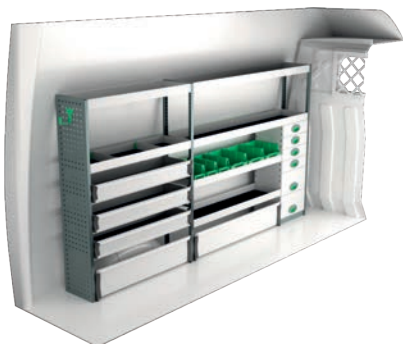

Art.No	LxDxH	Kg
F41426	2662x300x1440 mm	96

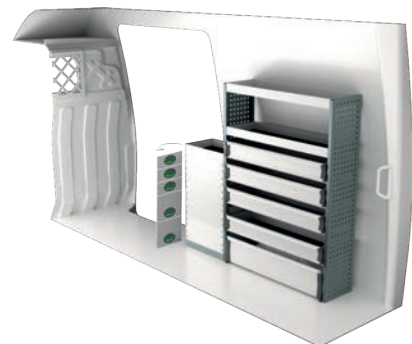

Art.No	LxDxH	Kg
F41427	1531x300x1440 mm	75

# IVECO DAILY 12 M<sup>3</sup> H2

For price information, mounting time and content in our van racking packages, scan the QR code on the first page.

On electric and hybrid vans we recommend mounting by an experienced installer. Batteries and cable harnesses for approximately 400 volt must be taken in consideration. Cost of a floor may be added.

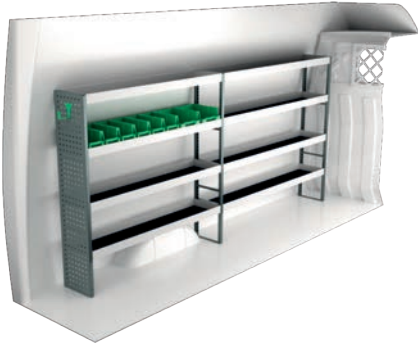

Art.No	LxDxH	Kg
F41440	3054x300x1440 mm	64

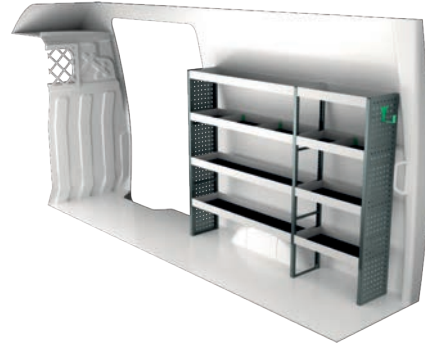

Art.No	LxDxH	Kg
F41441	1880x300x1440 mm	44

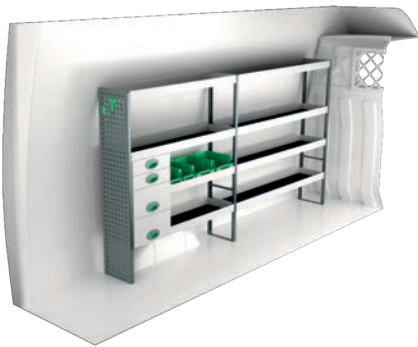

Art.No	LxDxH	Kg
F41442	2662x300x1440 mm	72

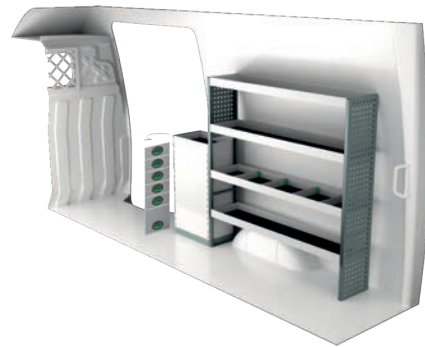

Art.No	LxDxH	Kg
F41443	1924x300x1440 mm	67

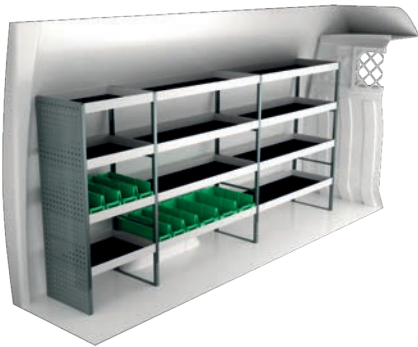

Art.No	LxDxH	Kg
F41444	3086x470x1440 mm	96

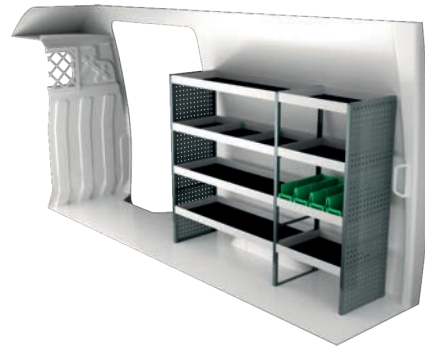

Art.No	LxDxH	Kg
F41445	1880x470x1440 mm	66

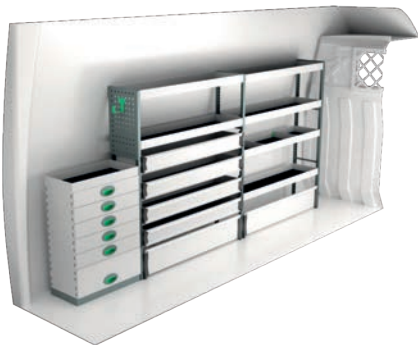

Art.No	LxDxH	Kg
F41446	3053x300x1440 mm	109



Art.No	LxDxH	Kg
F41447	1955x300x1440 mm	89

# IVECO DAILY 16 M<sup>3</sup> H2

For price information, mounting time and content in our van racking packages, scan the QR code on the first page.

On electric and hybrid vans we recommend mounting by an experienced installer. Batteries and cable harnesses for approximately 400 volt must be taken in consideration. Cost of a floor may be added.

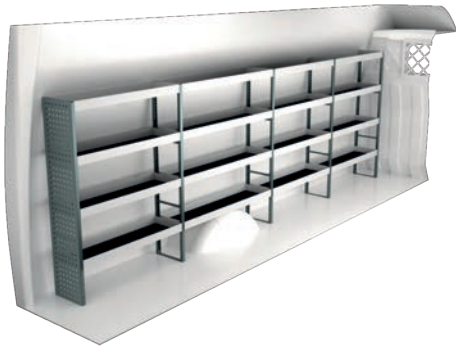

Art.No	LxDxH	Kg
F41460	4323x300x1440 mm	89

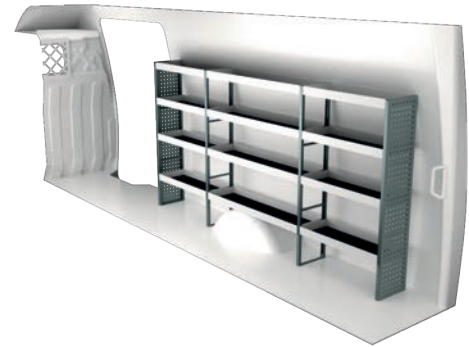

Art.No	LxDxH	Kg
F41461	2870x300x1440 mm	60

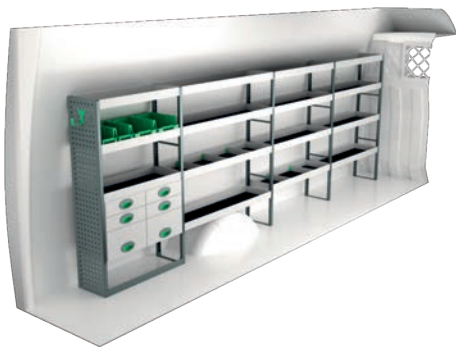

Art.No	LxDxH	Kg
F41462	4110x300x1440 mm	110

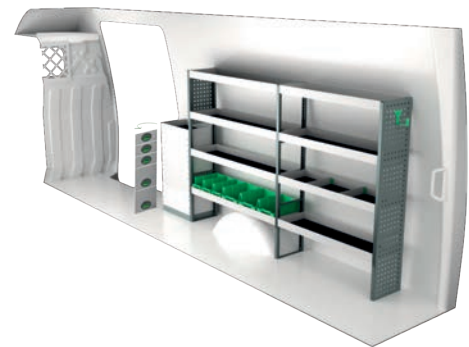

Art.No	LxDxH	Kg
F41463	2736x300x1440 mm	83

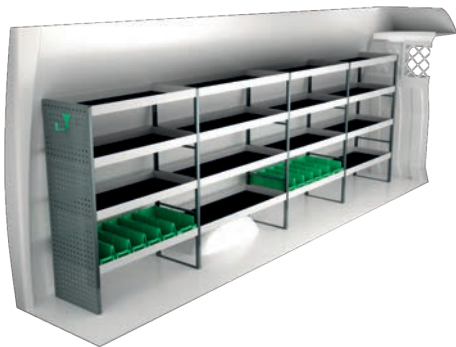

Art.No	LxDxH	Kg
F41464	4323x470x1440 mm	129

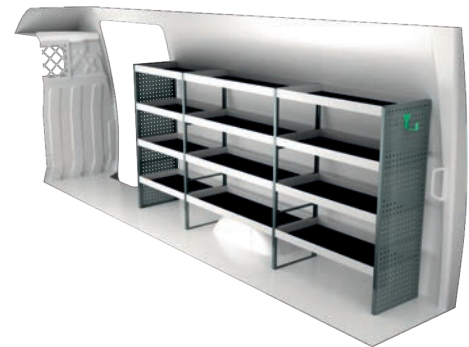

Art.No	LxDxH	Kg
F41465	3083x470x1440 mm	96

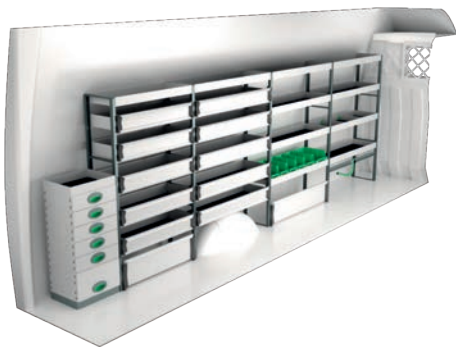

Art.No	LxDxH	Kg
F41466	4322x300x1440 mm	147

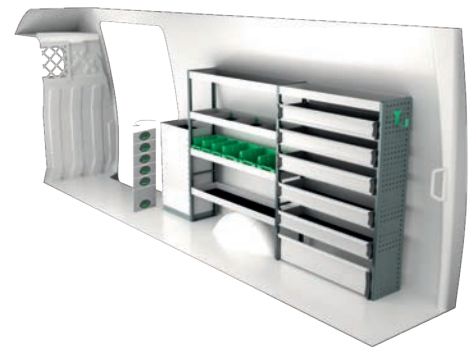

Art.No	LxDxH	Kg
F41467	2737x300x1440 mm	104

# IVECO DAILY 17,5 M<sup>3</sup> H2

For price information, mounting time and content in our van racking packages, scan the QR code on the first page.

On electric and hybrid vans we recommend mounting by an experienced installer. Batteries and cable harnesses for approximately 400 volt must be taken in consideration. Cost of a floor may be added.

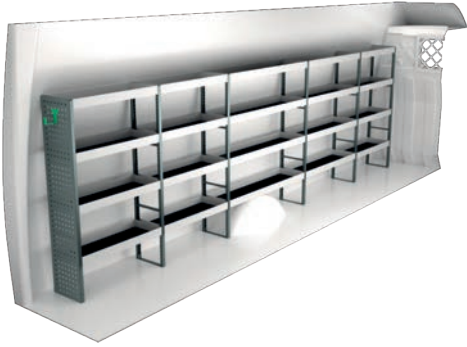

Art.No	LxDxH	Kg
F41480	4712x300x1440 mm	94

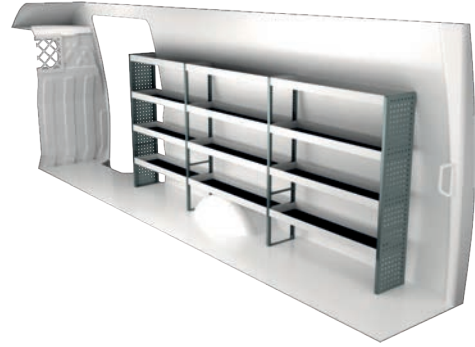

Art.No	LxDxH	Kg
F41481	3475x300x1440 mm	74

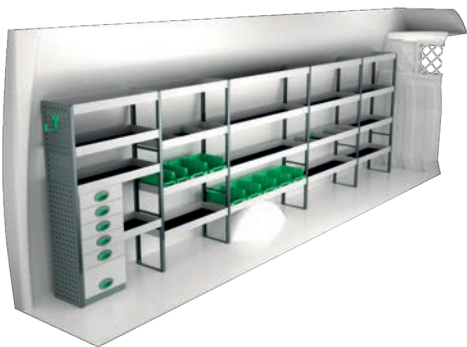

Art.No	LxDxH	Kg
F41482	4746x300x1440 mm	123

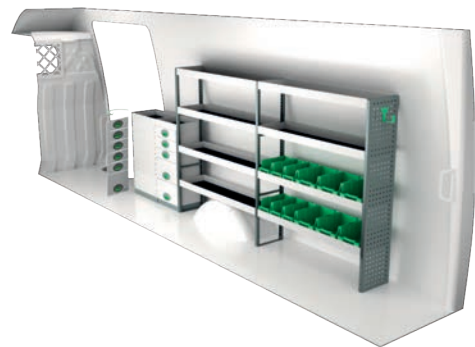

Art.No	LxDxH	Kg
F41483	3308x300x1440 mm	116

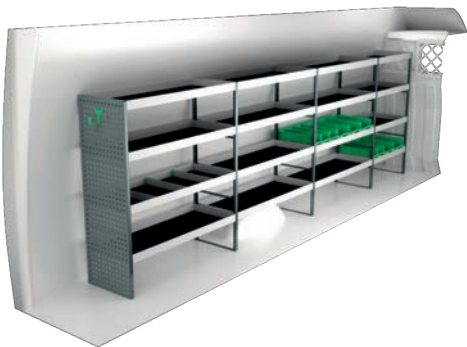

Art.No	LxDxH	Kg
F41484	4468x470x1440 mm	134

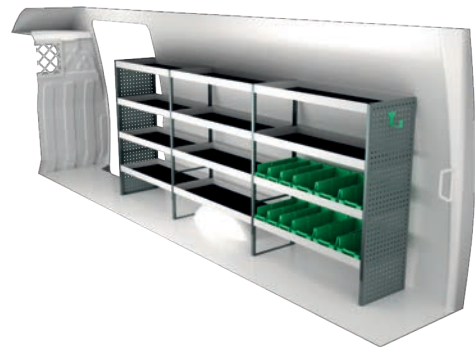

Art.No	LxDxH	Kg
F41485	3475x470x1440 mm	111

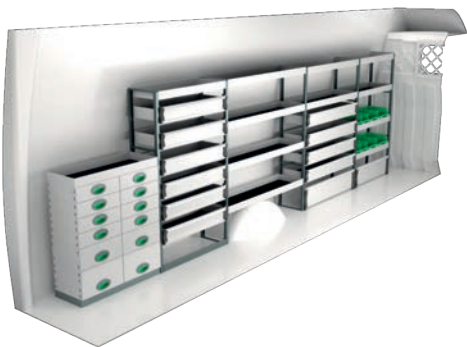

Art.No	LxDxH	Kg
F41486	4680x300x1440 mm	175

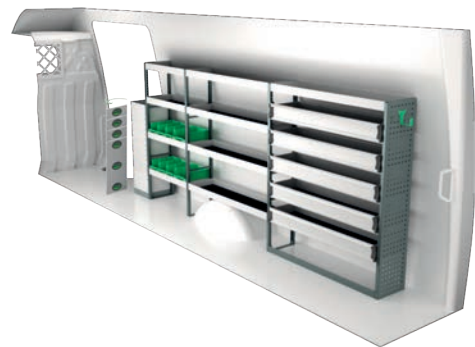

Art.No	LxDxH	Kg
F41487	3470x300x1440 mm	114

# IVECO DAILY 13,4 M<sup>3</sup> H3

For price information, mounting time and content in our van racking packages, scan the QR code on the first page.

On electric and hybrid vans we recommend mounting by an experienced installer. Batteries and cable harnesses for approximately 400 volt must be taken in consideration. Cost of a floor may be added.

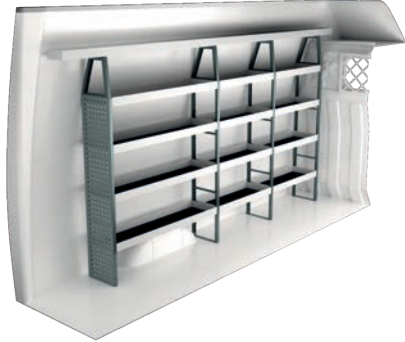

Art.No	LxDxH	Kg
F41500	2868x300x1795 mm	72

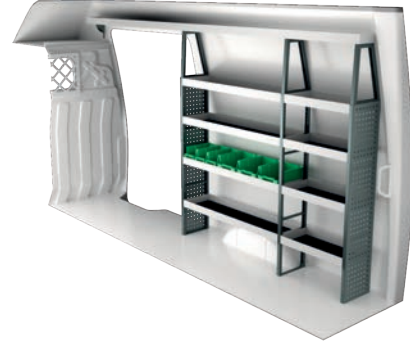

Art.No	LxDxH	Kg
F41501	1876x300x1840 mm	61

# IVECO DAILY 18 M<sup>3</sup> H3

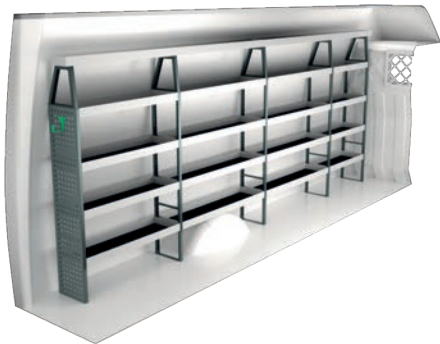

Art.No	LxDxH	Kg
F41520	4288x300x1795 mm	108

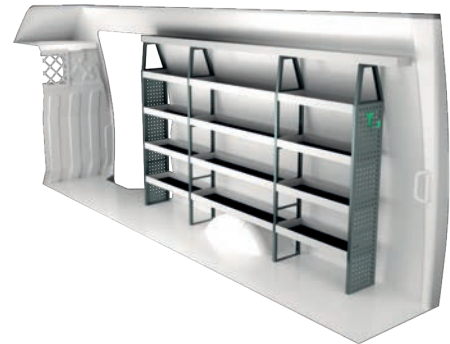

Art.No	LxDxH	Kg
F41521	2870x300x1795 mm	75

# IVECO DAILY 19,6 M<sup>3</sup> H3

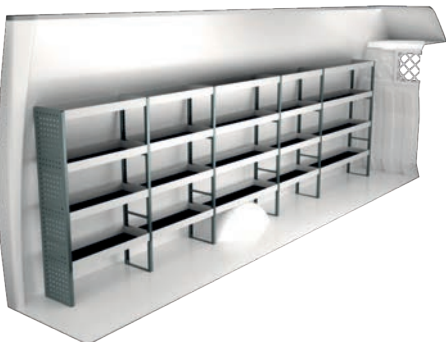

Art.No	LxDxH	Kg
F41540	4712x300x1440 mm	94



Art.No	LxDxH	Kg
F41541	3475x300x1840 mm	88

# INFORMATION



## GENERALLY

The kits include what you see in the drawing as well as installation parts, rubber mats to all shelves and foam to the drawers.

System Edström Bilinredningar AB is certified according to SS-EN ISO 9001:2015 to secure the administrative quality and to give us the possibility to keep a high accuracy on deliveries.

All material used in System Edström can be recycled to 100%. We are also certified according to SS-EN ISO 14001:2015.



## REMEMBER

Now that you have chosen to have System Edström in your vehicle you have taken the first and most important step to make your mobile workshop safe and functional. From here on it is up to you how safe and functional your working place will be.

Remember; You as the driver has the full responsibility if you or any one else is injured if the cargo is poorly secured. It is also your responsibility to make sure that the interior is mounted in the safest way possible whatever your choice of workshop, even if they are professionals with knowhow and long experience.

Make sure NOT to exceed the maximum payload of the vehicle.



## SECURITY

We crash test our racking continuously at RISE Research Institute of Sweden AB. The crash tests are carried out according to the standard INRS NS 286 which applies to van racking.

Other types of tests are also carried out at test institutes, for example shake tests that simulate several years of use on the road. We also carry out our own tensile and pressure tests, to check, for example, the strength of load securing products.

Find out more about our company and products at [www.systemedstrom.com](http://www.systemedstrom.com).



### Vice

Depth	Width	Height	Kg	Part.No
360	135	140	10,3	5004

The forged vice is complete with pipe jaw and turning plate. Max opening 140 mm.



### Vice Holders

Depth	Width	Height	⇔	Kg	Part.No
1110	170	195	600	9,4	5012
1110	170	80	600	8,9	5013

Plate measurement 170x158 mm. Cover 2950 is included.

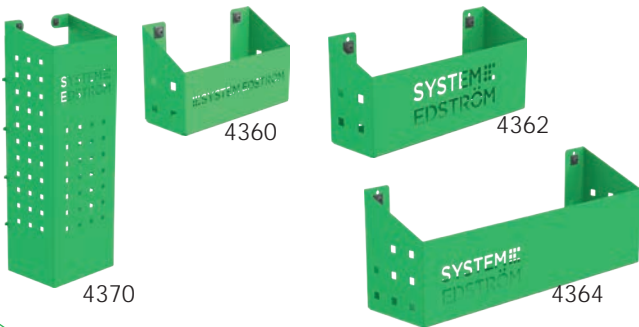

### Pegboard tray

Depth	Width	Height	Kg	Part.No
82	200	80	0,5	4360
82	285	102	0,8	4362
122	455	122	1,5	4364
153	179	575	3,0	4370

A number of different trays that solve (almost) all storage problems.



### Internal ladder holder

Length	Kg	Part.No
2400	5,5	T8900

Store your ladder on the inside of the roof, pull it back to the rear door in a simple operation. The aluminum rail comes in two parts with a joining piece.





### Hose/Cable rack

Depth	Width	Height	Kg	Part.No
79	267	168	0,5	4077

### Tube holder

66	194	123	0,4	4349
----	-----	-----	-----	------

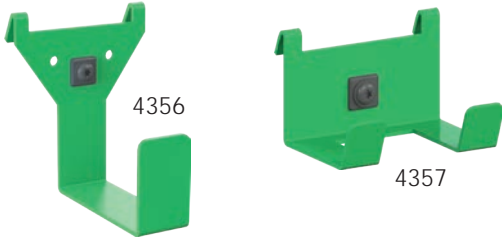

### Universal hook

Depth	Width	Height	Kg	Part.No
85	80	100	0,2	4356
61	83	55	0,1	4357

Simplicity at its best, heavy duty hooks, to be mount on a pegboard or hang it on the edge of a shelf.

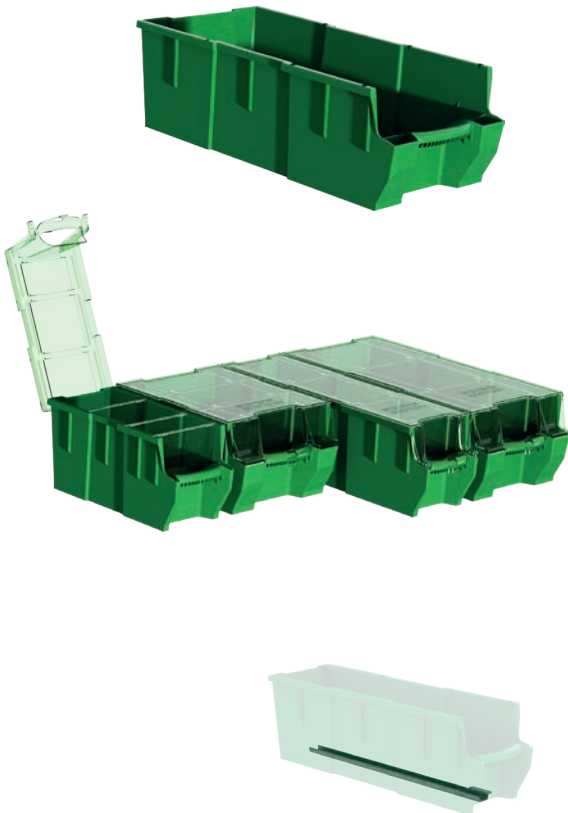

### Plastic bin for shelves

Depth	Width	Height	Kg	Part.No
300	145	154	0,4	3050
300	235	154	0,5	3052
470	145	154	0,5	3055
470	235	154	0,5	3057

### Transparent lid for plastic bins

Depth	Width	Fits	Kg	Part.No
300	150	3050	0,2	3060
300	240	3052	0,2	3062
470	150	3055	0,2	3065
470	240	3057	0,4	3067

### Dividers for plastic bins

Width	Height	Fits	Part.No
140	154	3050, 55	3070
230	154	3052, 57	3072

### Bracket for dropfront shelves

Depth	Kg	Part.No
300	0,1	3081
470	0,2	3082

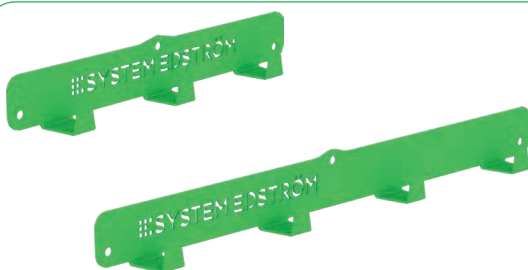

### Clothes hook

Depth	Width	Height	Kg	Part.No
31	295	40	0,3	2706
31	465	40	0,5	2708

We call it a clothes hook but, needless to say, you can use it to hang up whatever you want on it.



### Strap with brackets

Information	Width	Part.No
1200 mm, nylon strap	25	4365
1000 mm, elastic strap	25	4366

The brackets will fit on our pegboards.



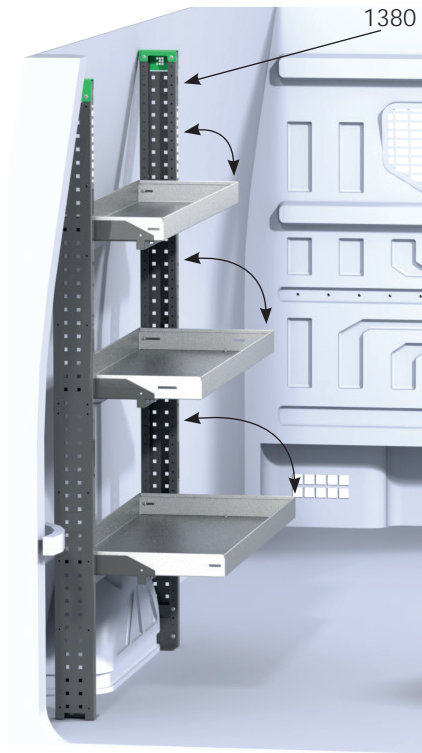

### Flexi shelf frame

Depth	Width	Height	Info.	Kg	Part.No
112	32	1788	2/set	11,8	1380
112	31	1788	1/set	4,9	1382

### Flexi shelf support

Depth	Width	Height	Shelf w.	Kg	Part.No
275	830	83	784	3,1	1308
275	1043	83	997	3,5	1312
275	1222	83	1176	3,9	1316
275	1435	83	1389	4,4	1322
275	1614	83	1568	4,8	1326

### Flexi shelf bracket

Information	Kg	Part.No
160 mm deep shelves, 2/set	0,6	1340
300, 400 & 470 mm deep shelves, 2/set	1,4	1342

### Flexi gas damper

Information	Kg	Part.No
2/set	0,1	1386

The shelf frames can be cut to fit your configuration. Loading capacity increases to 100 kg per shelf when mounted in a Flexirack. Shelves are adjustable to 4 pre-set angle on installation of 0, 4, 8 & 12 degrees.

Choose your shelves , 300, 400 and/or 470 mm depth. Our dropfront shelves will also fit, 300 and 470 mm depth. A shelf bracket will fit all different shelf depths.

Use the shelf bracket if you want to combine 160 mm deep shelves with other depths. 160 mm shelves are fixed, not foldable.

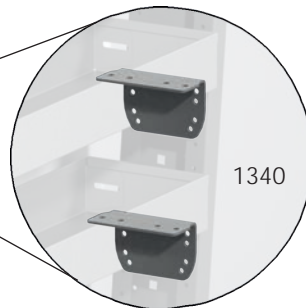

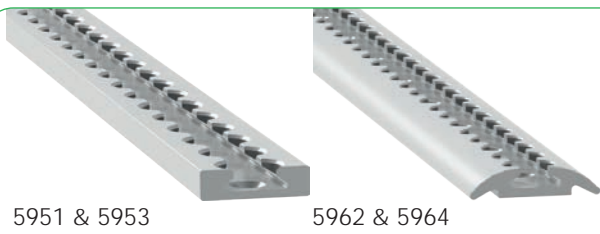

5951 & 5953

5962 & 5964



2813

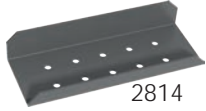

2814



5904



5905



5900

5901



5910



5911



5913



5915



5931 - 5935



5940



5993 & 5996

### Airline tracks

Length	Kg	Part.No
295	0,2	5951
465	0,2	5953
1000	0,8	5962
1500	1,2	5964
3000 > 6	2,5	5968

### Airline lashing rings

Information	Kg	Part.No
Round aluminium	0,0	5900
Straight black plastic	0,1	5901

### Airline brackets

Information	Kg	Part.No
Angle bracket 53x80x112 mm	0,2	2813
Support plinth bracket 175x66x15/32 mm	0,3	2814
Bracket for shelf frame	-	5904
Bracket for plywood	-	5905
T-nut 2xM6	-	5910
T-nut 3xM6	-	5911
Mounting bolt M8x25	-	5913
Clamp fitting	0,3	5915

### Airline straps

Information	Length	Kg	Part.No
Strap	200/ 700	0,1	5931
Strap	200/1200	0,1	5933
Strap	200/2200	0,2	5935
Strap with tensioner	500/2500	0,3	5940
Adjustable beam	1100-1660	2,6	5993
Adjustable beam	1600-2160	3,5	5996

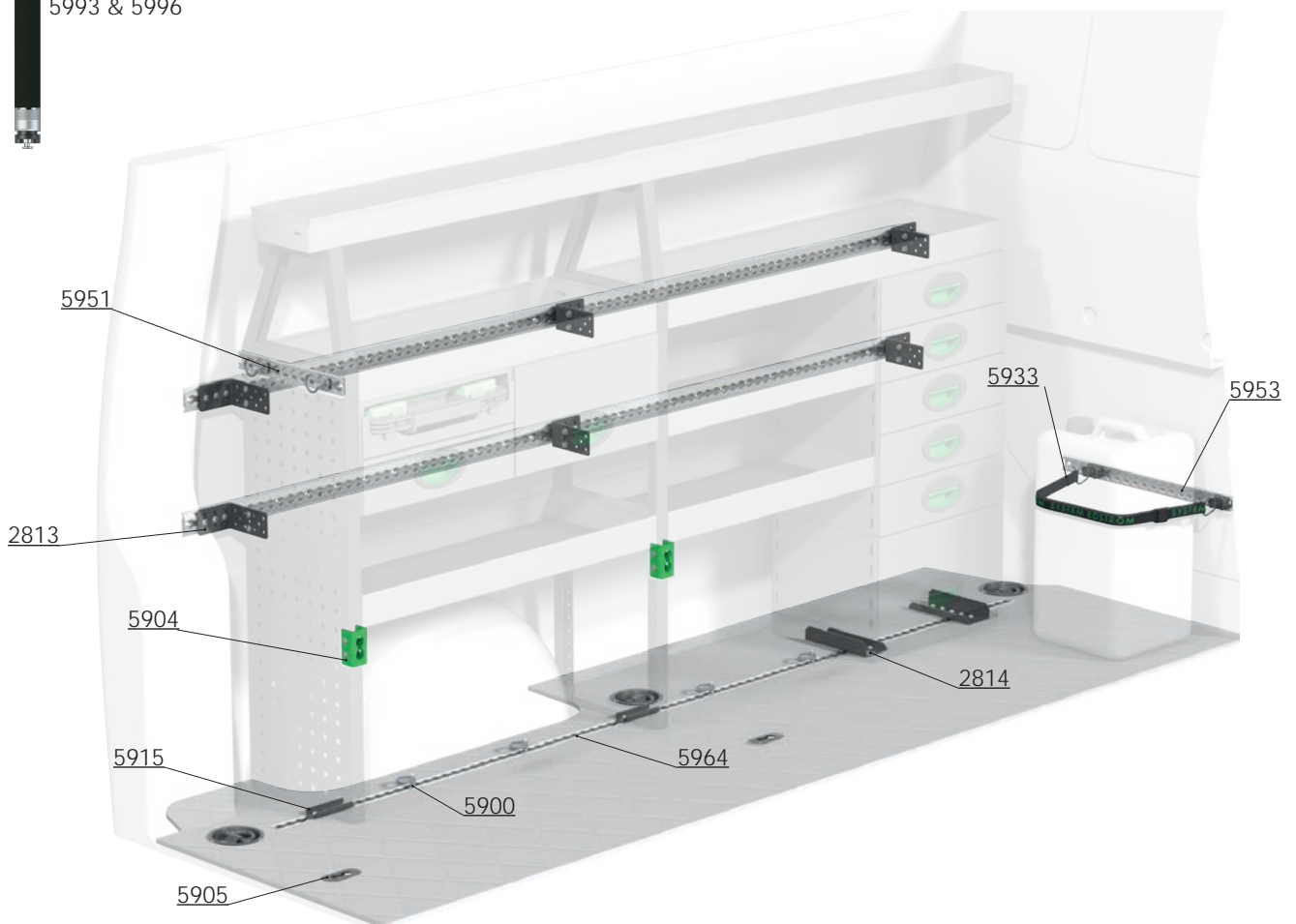



### Accessory package No. 1

### Accessory package No. 2

### Accessory package No. 3

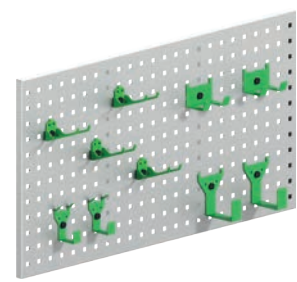
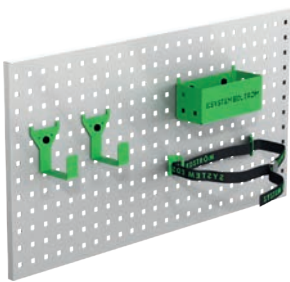

Art Nr

F11001

*Pegboard not included.*

Art Nr

F11002

*Pegboard not included.*

Art Nr

F11004

*Pegboard not included.*

[www.systemedstrom.com](http://www.systemedstrom.com)



WARRANTY



SAFETY

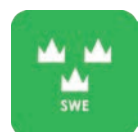

QUALITY

# SYSTEM EDSTRÖM

SYSTEM EDSTRÖM BILINREDNINGAR AB  
Raseborgsgatan 11  
164 74 Kista  
Sweden

### CONTACT

Order +46 (0)10 102 95 00

Sales +46 (0)10 102 95 01

Switchboard +46 (0)8 590 920 20

[info@edstrom.se](mailto:info@edstrom.se)